

Set Up Instructions

WLM-2000E

Step 1: Assemble straight poles by pressing and pushing together.

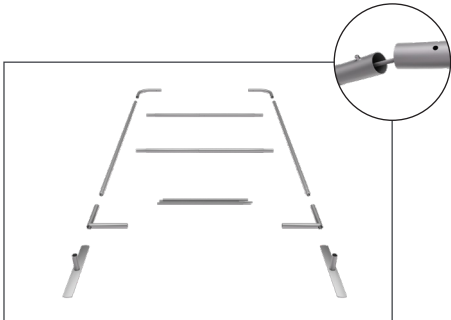

Step 2: Connect all corner sections to curved and straight sections of the frame by matching shape symbols on pipes.

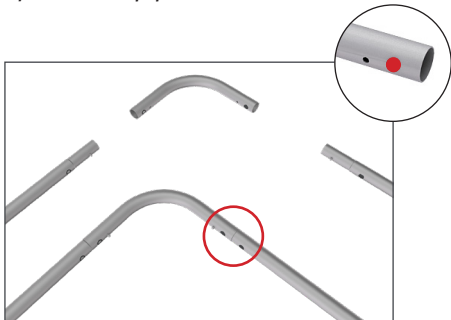

Step 3: Insert feet into base to complete assembled frame shown.

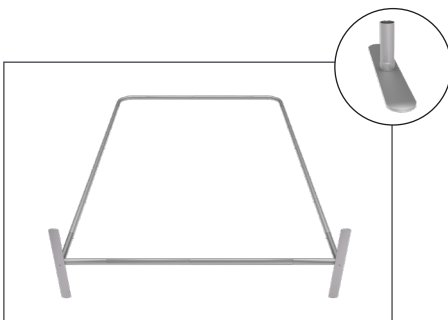

Step 4: Unzip print and lay image face up. Slide print onto frame like a pillow case.

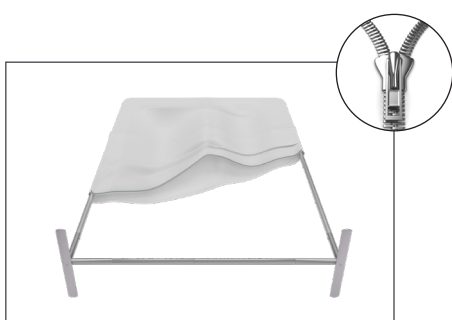

Step 5: Zip the edge of graphic beyond the center point as shown to hold the center pole in place. Zip the remaining side and bottom to meet at the corner.

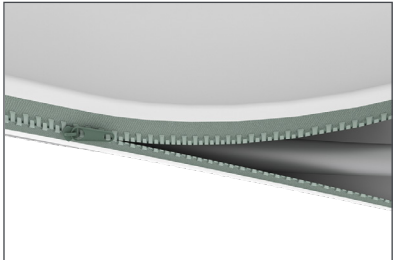

LIGHTS:
(OPTIONAL) Position as desired and tighten knob to hold in place.
WARNING! Over tightening may cause damage to fabric image.

Step 6: Complete.



Set Up Instructions

WLMEEEE KIT

FEET

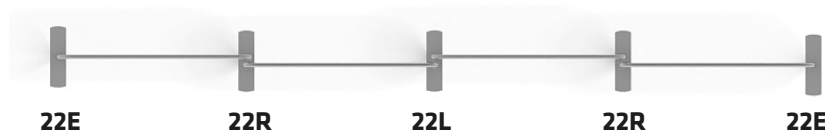
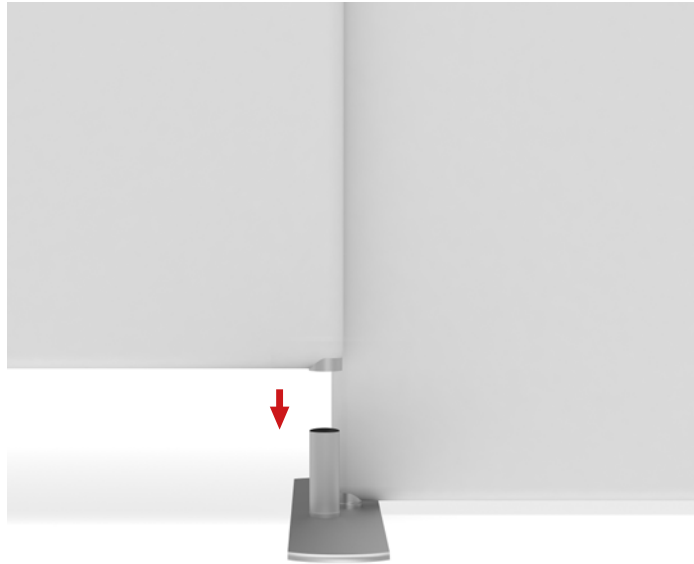

CLAMPS

